

Commode Companion Bidet Seat

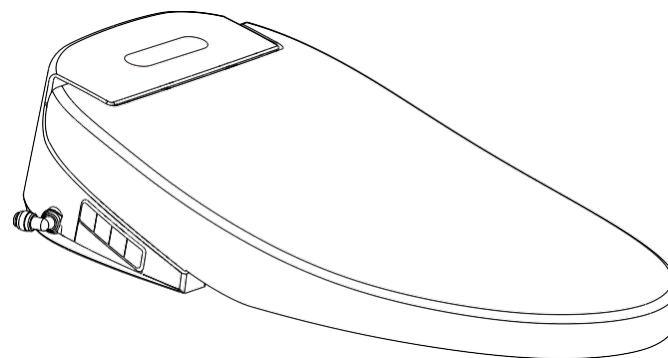

Product Manual

Thank you for using this product, To make it easier for you to use this product correctly.

Please read the User's Guide carefully and keep all the information in a safe place.

Warning

- This product must be used correctly. If it is incorrect, it will cause electric shock when failing and leakage. (Construction and confirmation of ground connection, please entrust professionals to do it)
- Do not power the product through an external switch device. (For example: timer or connect to a regular and disconnected circuit that is connected to the general component)
- Be sure to scrub the detergent after cleaning the machine, avoid it remain on the surface of the machine or on the gap between the toilet and the machine.
 - Do be sure to use the power cord and power plug correctly
 - If it is improper, it will cause fire or electric shock
 - Feem the rated 10A. AC 220V power socket.
 - Please confirm whether the power plug is actually inserted to the end before use.
 - When you need to unplug the power plug, you must hold the plug body with your hand and unplug it. Do not pull the power cord directly to pull out the power plug.
 - Do not insert the power plug with a wet hand.
 - Pay the dust on the power plug regularly.
 - Reward the power cord and power plug scratching, processing, close to high temperature, forcibly bending, holding, stretching, and laying heavy objectspower cable
 - At the power plug when you need to repair it, please contact customer service.
- If the soft line of the power supply is damaged in order to avoid danger, it must be replaced by professionals in the manufacturer, its maintenance department or similar department.
- Except for professional maintenance technicians authorized by the company, you must not be transformed, disassembled, and repaired without authorization to avoid causing electric shock, fire, and injury due to abnormal work.
- When the following abnormalities occur in this product, they must be stopped immediately when the failure, and the power plug is removed, the water inlet valve is turned off, and the after-sales service personnel are connected immediately.
 - The body or casual seat has cracks or damage.
 - The abnormal sound or scorching smell.
 - In the power line, the power supply is intermittent.
 - The power plug or power cord is abnormal.
 - The body or operation department is hot and abnormal.
- Do not put the lit cigarettes and other combustion into the toilet.
- Do not use tap water and drinking water sources other than water (groundwater).
 - It will cause water leakage due to impurities in the water or foreign body adhesion.
 - Cystitis and skin inflammation will cause cystitis and skin inflammation because water contains microorganisms such as bacteria.
- When using the following populations, the temperature of the seat circle should be adjusted to low (long-term contact with the stool and the skin will cause low temperature burns).
 - Those who are sensitive or slow for children and elderly people, who cannot take temperature regulators, take hypnotic drugs (such as sleeping pills), drunk and extreme fatigue.

Notice

- Before using it, confirm whether the leakage protection device is working properly; when the leakage protection device is faulty, the product is used.
- Do not insert it into the opening of this product, so as not to cause electric shock.
- When you do not use this product for a long time, please discharge the water on the water side of the product (please refer to "maintained maintenance"), and then unplug the power plug.
- If the remaining water is discharged the deterioration of water will cause skin inflammation.
- Please abide by the following precautions to avoid injuries.
 - When handling, you must hold the body with both hands. If you hold the seat or cover with one hand, the body will be injured away from the body.
 - When the stool and the stool are opened and closed, please be careful not to pinch your fingers.
 - Do not rely on the cover, it will fall or injury due to the rupture of the stool.
 - Do not sit above the cover or exert impact, it will fall and injury due to the rupture of the stool.
 - Do not support the body's control panel to sit down, stand up or sit directly on the control panel, which will cause falling and injury.
 - When operating the control panel button or closing the toilet cover, do not use brute force, it will cause injuries due to damage.
 - Do not continue to use it when the body's part is falling off, causing injuries to fall or cause injuries due to rupture.
- Do not let children play this product and accessories, so as not to cause injuries and suffocation.
- People with disabilities and people who lacks experience or common sense (including children) need to use this product under special personnel.
- To connect water source appliances from detachable hose components, it is necessary to replace it with a new hose component. The old hose component cannot be reused.

Maintenance instruction

1. Daily maintenance method

- Make sure the power supply is disconnected.
- Do not let the water enter the product inside during the maintenance process.
- Be sure to scrub the detergent after clean the machine, avoid it remain on the surface of the machine or on the gap between the toilet and the machine.

2. Maintenance points

- Clean on the surface of the machine

Wipe the machine with a wet and soften cloth. If the machine surface is dirty, you can dip a little of neutral washing detergent on the soften cloth to wipe on it again.

- Maintenance of the spray rod (under power supply)

1. Press the sprinkler self-cleaning key on the remote control without seat on, and the spray rod will extend on automatically.
2. Use a soften wet cloth or brush to wipe on the surface and outlet of the spray rod, be careful the deformation of the spray rod damaged or deformation.
3. Touch the stop button after maintenance, the spray rod will recover to the interior of the machine automatically.

Common fault treatment

S/N	Failure name	Fault symptom	Failure measures and steps
1		Plug indicator light is not on	Check on whether the leakage protection plug is insert well Whether the leakage switch trips and reset on it Power cut or not
2	Water is not come out from the nozzle	No water comes out	Water supply stop or not, wait for the restoration of water supply Valve opens or not, open the valve Three way valve is block or not, and clean the three way valve after close on the valve Check whether the water inlet pipe is folded or not, straighten it out
3	Water flow out rate is slow	Low water pressure	Water pressure is normal or not, wait for the restoration of water supply Valve opens or not, open the valve Three way valve is block or not, and clean the three way valve after close on the valve Check whether the water inlet pipe is folded or not, straighten it out Set on the highest setting for the clean water level
4	Water is not heating	Abnormal water supply	Whether the water volume is small or suddenly, the water source in the home is caused by the unstable source of the home The toilet flushing function has just caused the toilet water tank to enter the water, which affects the amount of water.
		Improper settings	Whether the water temperature is set in the normal temperature gear, and the gear is reset.
5	Nozzle is not at the place	Improper settings	Check whether the cleaning position is in the last gear, or return on the power after disconnecting the main power
		Unable to stretch out	Press the seat sensor when you are not seat on, enter the seating state, and then turn on the cleaning function. If the nozzle can extend it, the main reason is that the ceramic deformation is too large. Method IV, 5.4 adjustment.
6	Blowing cold wind when drying	Incorrect setting	Wind temperature gear setting is correct or not, reset on
7	Press buttons not works, remote control not works	Seat on or not	Check on if you are seat on, the machine is not executed any orders without seat on state.
		Remote control receiver is works or not	Remote control receiving disturbance caused the receiving not to be lit, re -code, press the shower key for 5 seconds, and then press the shower key on the remote control after listen on a remind voice.
		Insufficient electricity volume of remote control device	Remote control device is caused by insufficient electricity, change the battery
8	Seat temperature is not heating	Incorrect setting	The settings are improper, whether the gear settings are accurate, and increase the temperature gear to a higher level
9	Shows E1, E2, E6	Water temperature is too low, too high, and the water supply is abnormal	This kinds of code appears is caused by water supply. Power off confirmation of water supply and re -power supply.

Product description

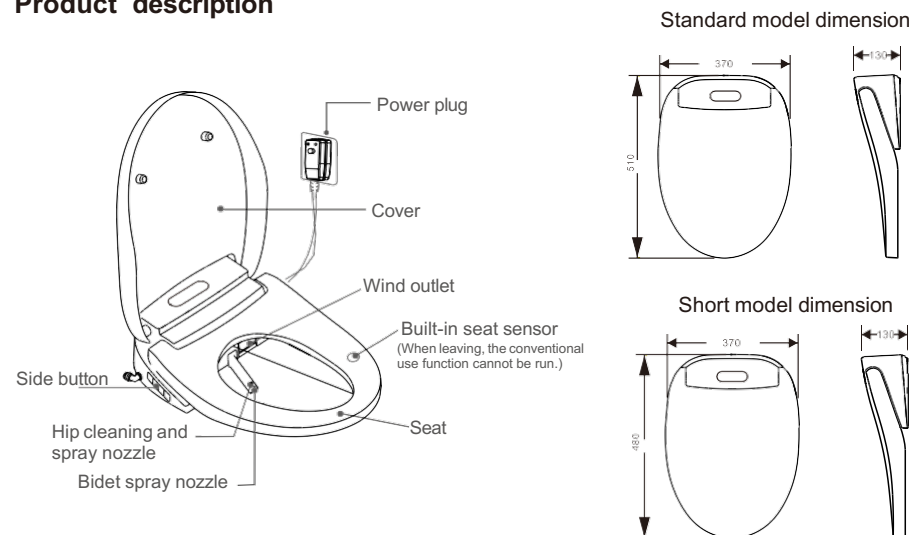

Product Specifications

Name		Commode Companion Bidet Seat	
Rated voltage		<input type="checkbox"/> AC 220V 50Hz	<input type="checkbox"/> AC 110V 60Hz
Rated power		1300W (water inlet temperature, ambient temperature, the maximum of the seat temperature setting, the maximum flow of hip washing settings, the highest water temperature)	
Power line length		1.2 meter	
Water supply method		Directly connect	
Water pressure		0.08MPa-0.8MPa	
Safety device		Leakage protection, seat induction, water over voltage protection device	
Washing device	Heating method		Instant heating
	Washing water temperature		4 gears (Room - about 40°C)
	Rinse flow rate	Shower	About 0.5-0.8L/min
		Bidet	About 0.5-0.8L/min
	Rinse method	Shower	Mixed flushing
Bidet		Mixed flushing	
Safety device		Temperature control switch	
Warm air drying	Wind temperature adjustment		Normal temperature, low, medium, high (Room - about 55°C)
	Safety device		Dual metal sheet, temperature fuse
	Wind speed		4-7m/s
Seat device	Temperature of the seat		4 gears (Room - about 40°C)
	Safety device		Temperature fuse
	Switch structure		Seat base and seat cover adopt a damping slowdown device

Note: The temperature of the dry temperature is 5cm away from the air outlet.

When the water supply and water pressure is lower than 0.08MPa, it is recommended to install a supercharged pump, otherwise it may affect normal use.

Installation list

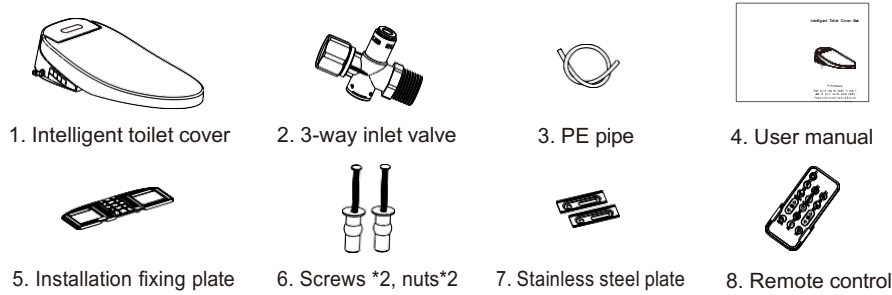

Installation requirements

1. Confirm the requirements of ceramic size

	Standard	Short
Distance from the front end to water tank A	> 490	< 490
Distance from the front end to installation hole B	445-474	417-446
Distance from the front end to the back wall of the basin C	> 384	> 356
Centre separation D of Installation hole	115-185	115-185

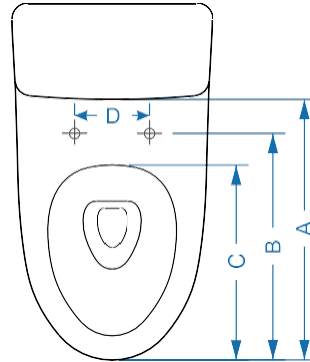

2. Check the power and water supply

- This product is for AC220V/110V, 50Hz/60Hz power supply, and the power socket should meet 220V/110V, 10A/16A specifications.
- When using this product, the tap water pressure must be 0.08MPa-0.8MPa.
- When using water pressure lower than 0.08MPa, it is recommended that users install a booster pump, otherwise it may affect normal use.
- Do not connect the power supply before the installation is completed.
- Be sure to connect the grounding wire. If there is no grounding condition, please commission electrical professionals to install it.

Product installation

Attention:

1. Before connecting the 3-way inlet valve, the angle valve must be opened to drain for more than 1 minute to remove the grit and dirt from the pipe.
2. For water apparatus connected by removable hose assembly, it must be replaced with a new hose assembly, and the old hose assembly cannot be reused.

1 Remove the installed toilet cover
If the nut is rusty and cannot be loosened, use the commercially available spray for loosening screws to loosen it.

- 1 Loosen the bolt with an wrench
- 2 Remove the nut and gasket, and the remove the toilet cover

2 Put two fixed rubber expansion tubes into ceramic body

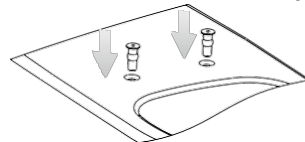

High configuration(with flip cover) remote control function description

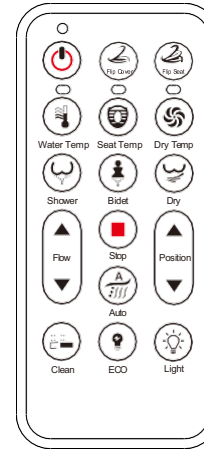

— Press “” to turn off the power to the whole machine. Press this button repeatedly to power on the whole machine.

— Flip cover

When not seated, press “” to open the seat cover; press this button repeatedly to close the seat cover.

— Flip seat

1. When not seated, press “” to open the seat; press this button repeatedly to close the seat.

2. If the seat cover and the seat are in the closed position at the same time, press “” to open the seat and seat cover.

— Water Temp

Press “” wash water temperature for cycle setting: Normal (no indicator light); Low (approx. 34°C, indicator light blue); Medium (approx. 37°C, indicator light pink); High (approx. 40°C, indicator light red).

— Seat Temp

Press “” seat temperature for cycle setting: Normal (no indicator light); Low (approx. 34°C, indicator light blue); Medium (approx. 37°C, indicator light pink); High (approx. 40°C, indicator light red).

— Dry Temp

Press “” dry temperature for cycle setting: Normal (no indicator light); Low (approx. 40°C, indicator light blue); Medium (approx. 50°C, indicator light pink); High (approx. 55°C, indicator light red).

— Shower

When the human body is seated, press “”, the hip wash function to start working. Press “” again, the spray bar stops reciprocating cleaning. The working time is 90 seconds.

— Bidet

When the human body is seated, press “”, the female cleaning function to start working. Press “” again, the spray bar stops reciprocating cleaning. The working time is 90 seconds.

— Dry

When the human body is seated and press “”, the warm air can be turned on after drying, and the cycle working time is 180 seconds.

— Flow

During the cleaning process, press the button “” “” can adjust the wash water flow, the flow is divided into 4 grades, the cover beeps according to the gear.

— Stop

Press “”, to stop the automatic cleaning, hip cleaning, female cleaning, warm air drying, spray bar manual cleaning, etc. Function operation.

— Position

In the process of cleaning press this key “” “” can be adjusted to the cleaning position.

— Auto

When the human body is seated and press “”, the spray bar automatically extends to clean the hips. Press again, spray bar stop reciprocating cleaning for fixed position cleaning. Working time 90 seconds. After cleaning, it automatically goes into drying.

— Clean

Press “”, when the human body is not seated, the spray bar automatically extended, then you can manually clean the spray bar, 1 minute after the spray bar automatically retracted.

— ECO

Press “” to turn on or off the ECO function. When opening, the ECO indicator on the cover will turn on, and the cover will beep twice, and when it is closed, the ECO indicator will beep once when the cover is closed. When the ECO function is turned on, it is automatically converted to 25°C when the human body leaves the seat, and the ECO function is automatically exited after the human body is seated according to the original setting.

— Light

Turn the night light on or off when you press “”.

General remote control function description

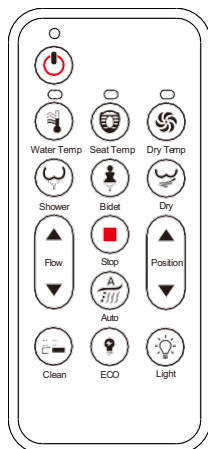

— Press “” to turn off the power to the whole machine. Press this button repeatedly to power on the whole machine.

— Water Temp

Press “” wash water temperature for cycle setting: Normal (no indicator light); Low (approx. 34°C, indicator light blue); Medium (approx. 37°C, indicator light purple); High (approx. 40°C, indicator light red).

— Seat Temp

Press “” to turn the seat temperature on or off: When the seat temperature is turned on, the blue light on the remote control will be on, and the cover will display the set temperature, and the cover will sound two prompts; When the seat temperature is turned off, the red light on the remote control will be on, and the cover will display 00, and the cover will sound a prompt.

— Dry Temp

Press “” to turn the air temperature on or off: when the air temperature is turned on, the blue light on the remote control lights up, the cover displays the set temperature, and the cover sounds two prompts; when the air temperature is turned off, the red light on the remote control lights up, the cover displays 00, and the cover sounds a prompt.

— Shower

When the human body is seated, press “”, the hip wash function to start working. Press “” again, the spray bar stops reciprocating cleaning. The working time is 90 seconds.

— Bidet

When the human body is seated, press “”, the female cleaning function to start working. Press “” again, the spray bar stops reciprocating cleaning. The working time is 90 seconds.

— Dry

When the human body is seated and press “”, the warm air can be turned on after drying, and the cycle working time is 180 seconds.

— Flow

During the cleaning process, press the button “” “” can adjust the wash water flow, the flow is divided into 4 grades, the cover beeps according to the gear.

— Stop

Press “”, to stop the automatic cleaning, hip cleaning, female cleaning, warm air drying, spray bar manual cleaning, etc. Function operation.

— Position

In the process of cleaning press this key “” “” can be adjusted to the cleaning position.

— Auto

When the human body is seated and press “”, the spray bar automatically extends to clean the hips. Press again, spray bar stop reciprocating cleaning for fixed position cleaning. Working time 90 seconds. After cleaning, it automatically goes into drying.

— Clean

Press “”, when the human body is not seated, the spray bar automatically extended, then you can manually clean the spray bar, 1 minute after the spray bar automatically retracted.

— ECO

Press “” to turn on or off the ECO function. When opening, the ECO indicator on the cover will turn on, and the cover will beep twice, and when it is closed, the ECO indicator will beep once when the cover is closed. When the ECO function is turned on, it is automatically converted to 25°C when the human body leaves the seat, and the ECO function is automatically exited after the human body is seated according to the original setting.

— Light

Turn the night light on or off when you press “”.

3 Install the fixing plate onto the ceramic body.

- Put the stainless steel plate onto the fixing plate and put the fixing plate on the ceramic body with the opening outward.
- Fix the fixing plate on the ceramic with screw, and adjust the position of the fixing plate according to the right figure.

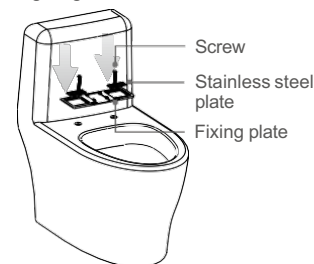

Standard style

Install the fixing plate in the middle

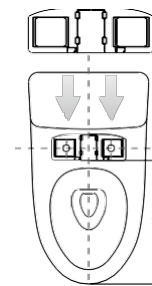

Short style

Install the fixing plate in the middle

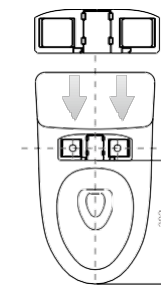

4 Install 3-way inlet valve

- Close the water inlet valve, remove the original water inlet pipe, temporarily connect the newly purchased ceramic water inlet tube to the water inlet valve, drain water for about 1 minute, and remove the water inlet tube.

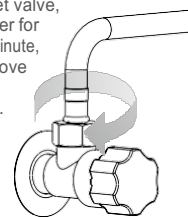

- Install the filter tee on the inlet angle valve.

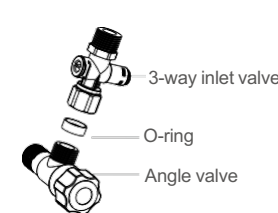

- The water inlet tube is connected to the 3-way inlet valve.

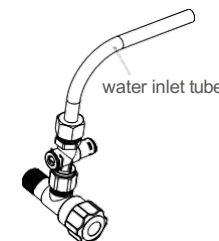

5 Install the toilet cover

- Align the toilet cover with the fixing plate and the slot, and slowly push it in. When it is pushed in place, a “cluck” will sound.

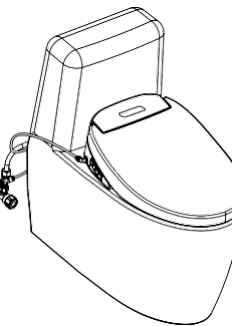
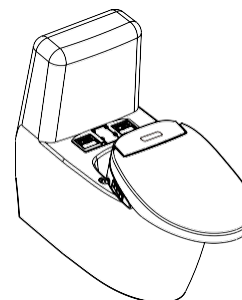

- Connect the water inlet PE pipe to the toilet cover and the 3-way inlet valve.

- Check that the gap between the bottom surface of the toilet cover and the ceramic surface, it should not be larger than 5mm. It can only be used when a suitable plastic block or wood board is padded in the middle, otherwise the cleaning nozzle may not protrude.

- Open the angle valve and check the connections to ensure that there is no water leakage.

- Insert the leakage protection plug into the plug socket, and the power indicator will light up.

- Leakage test: press the test button on the leakage plug, the power indicator shall be immediately turned off, and then started the button, the power indicator shall be on.

6 Remote control installation

1 Clean the wall

Clean the wall where the remote control would be installed and dry it in the air (pay attention to install it on a smooth surface that is not easy to fall off)



2 Remove the 3M separation paper

Uncover the release paper on the 3M double-sided adhesive tape behind the mounting base

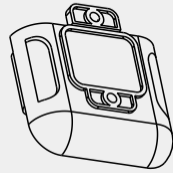

3 Install the remote control mounting base

Put the opening of the mounting base upward on the mounting wall and keep pressing for 30 seconds

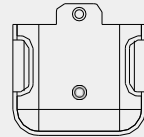

4 Install the remote control battery

Push back the battery cover of the remote control, turn the battery cover up, put in the button battery, and install the battery cover with the battery positive stage up

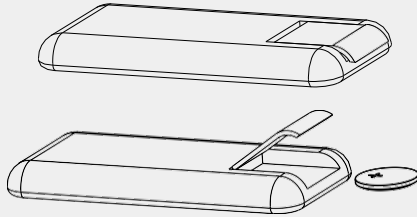

5 Install the remote control

Put the front of the remote control outward, the characters upward, put into the base from top to bottom.



7 Trial run

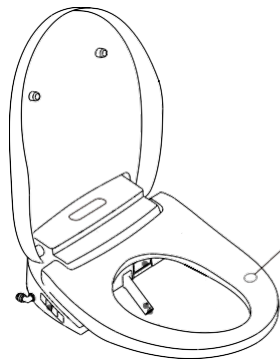

1. Connect the water pipe and open the water valve.
2. Turn on the power, complete the reset, and enter the standby mode.
3. Wet a towel and put it to the "seat induction position" on the seat ring. At this time, the cover plate makes two drips sound, indicating that it is OK.
4. Press the side button or the function button on the remote control in turn to check whether the machine can work normally.

Product Display

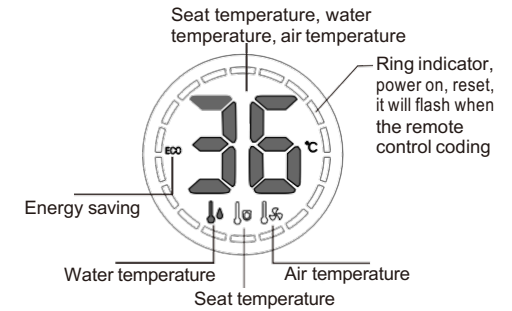
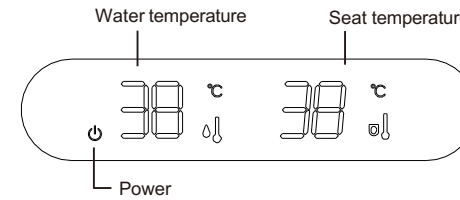

Product operation instructions

Standard model side button instructions

Warm air drying

■ After cleaning, press the button to operate the warm air drying function, in the drying process repeatedly press the button to adjust the wind temperature, through the sound of the buzzer to determine the gear, one off, two on.

Hip washing

■ After sitting, press the Shower button to start working. Repeat the button during the cleaning process to adjust the water volume. According sounds to determine the gear, which is cleaning with automatic reciprocating.

⊗ Note:
The nozzle will be automatically self-cleaned once before and after cleaning.

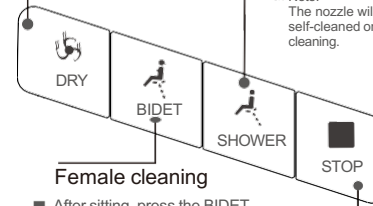

Female cleaning

■ After sitting, press the BIDET button to start working. Repeat the button during the cleaning process to adjust the water volume. According sounds to determine the gear, which is cleaning with automatic reciprocating.

⊗ Note: The nozzle will be automatically self-cleaned once before and after cleaning.

Stop

■ Press this button to stop working

Basic model side button instructions

Seat temperature

■ Press the button to turn on or turn off the seat heating, the buzzer sounded one to turn off the seat heating, two sounds to open the seat heating. Press the button for 5S without seats to turn off or turn on the light.

Hip washing

■ After sitting, press the buttocks washing button to start working. Repeat the button during the cleaning process to adjust the water volume. According sounds to determine the gear, which is cleaning with automatic reciprocating. Press the buttocks washing button in 5 seconds before sitting, then it will be manual cleaning nozzle status, press the stop button to exit.

⊗ Note: The nozzle will be automatically self-cleaned once before and after cleaning.

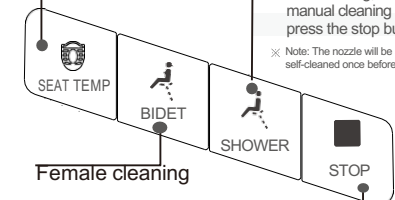

Female cleaning

■ After sitting, press the BIDET button to start working. Repeat the button during the cleaning process to adjust the water volume. According sounds to determine the gear, which is cleaning with automatic reciprocating.

⊗ Note: The nozzle will be automatically self-cleaned once before and after cleaning.

Stop

■ Press this button to stop working

Rotary switch description

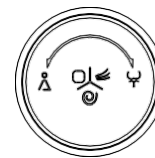

- When on seat, rotate the knob to the hip washing position clockwise (forward), and you can turn on the hip washing function. Repeat the clockwise rotation to adjust the water flow. At the same time, there will be a prompt sound of the corresponding gear.
- When on seat, rotate the knob to the female cleaning position counterclockwise (backward), and you can turn on the Female cleaning function. Repeat the counterclockwise rotation to adjust the water flow. At the same time, there will be a prompt sound of the corresponding gear.
- After seating, press the knob when the cleaning or drying program running, stop the current running program; press the knob in no function when running, it will open the drying function.
- Press and hold the knob for 3 seconds to turn the machine on or off.